

safety
ENGINEERING

sb SELF BELAY

OPERATIONS MANUAL

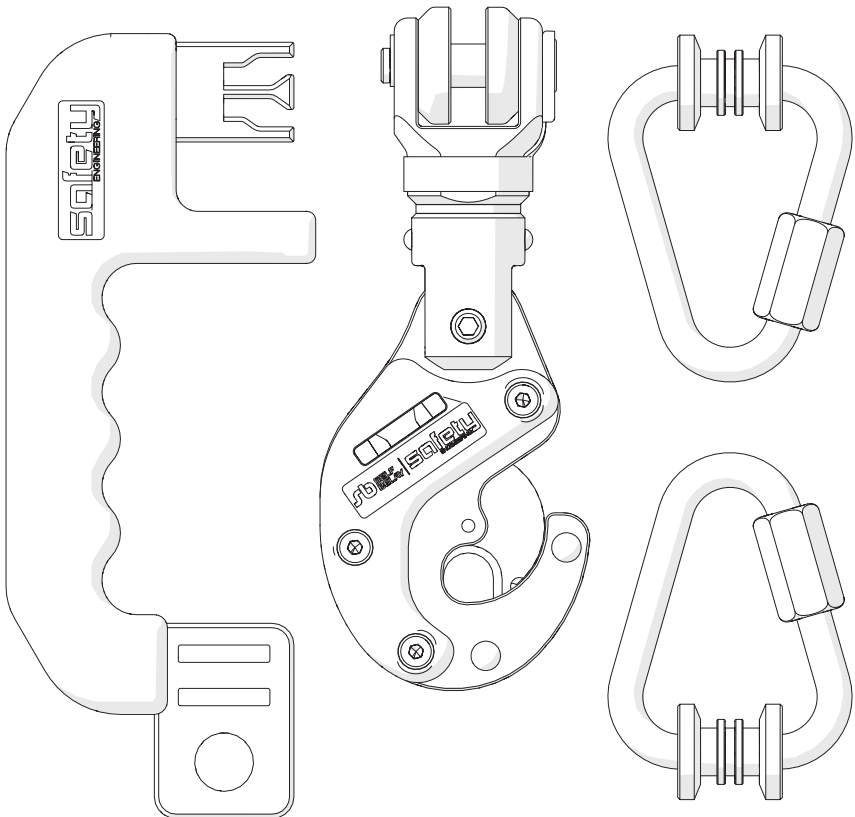

by **safety**
ENGINEERING

Last revision: 2023-04-25



WARNING: INSTALLERS AND OPERATORS MUST READ THIS OPERATIONS MANUAL AND COMPLETELY UNDERSTAND ALL REQUIREMENTS AND AGERE TO MAINTENANCE GUIDELINES.

Table of contents

Table of contents	2
1. Introduction and overview	3
2. Product identification	4
3. Certification	5
4. Manufacturer's Details	6
5. Conformity assessment	6
6. Register your device	6
7. Compatibility with autobelay devices and harness	6
8. Device specification	7
9. Installation	8
9.1. Prepare the Self Belay device	9
9.2. Installation on steel cable	10
9.3. Installation on textile webbing	11
9.4. Installation of quicklinks to user harness	12
9.5. Installation of Self Belay key	13
10. Usage of the Self Belay and Quicklink connector.....	13
11. Inspection and maintenance	17
11.1. Daily inspection	17
11.2. General care	21
11.3. Checklist	22
11.4. Annual maintenance and recertification	23
12. Lifespan	26
13. Warranty information	26
14. Declaration of conformity	27
15. Further information	27
16. Product Inspection	27

1. Introduction and overview

The Self Belay is a safety connector that is used for securing oneself to the end of an auto belay device. It adds to the safety of climbing through its unique design. The Self Belay Set is comprised of three main parts that come packaged inside the box.

Parts of Self Belay Set:

1. Self Belay device - 1 pcs
2. Self Belay key - 1 pcs
3. Self Belay quicklink - 2 pcs

These components together form the Self Belay Set.

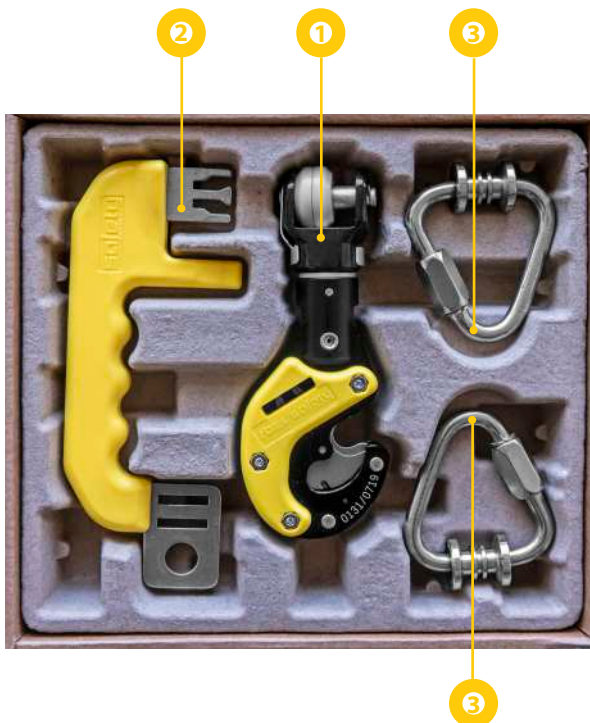

The Self Belay set includes this manual in printed form inside the cushioned showcase box; keep this manual for future reference. You can always download the latest version of this manual by visiting this address:



<https://safetyeng.eu/downloads/>





<https://safetyeng.us/downloads/>

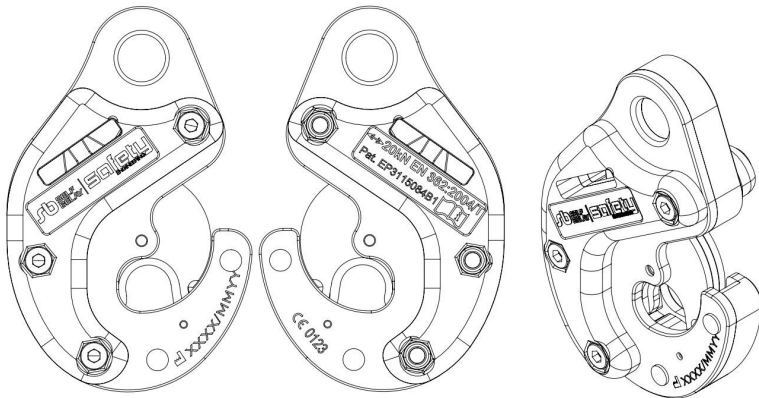

2. Product identification

Self Belay devices are marked with some identifying information. The Self Belay device and the accompanying quicklinks are marked individually.

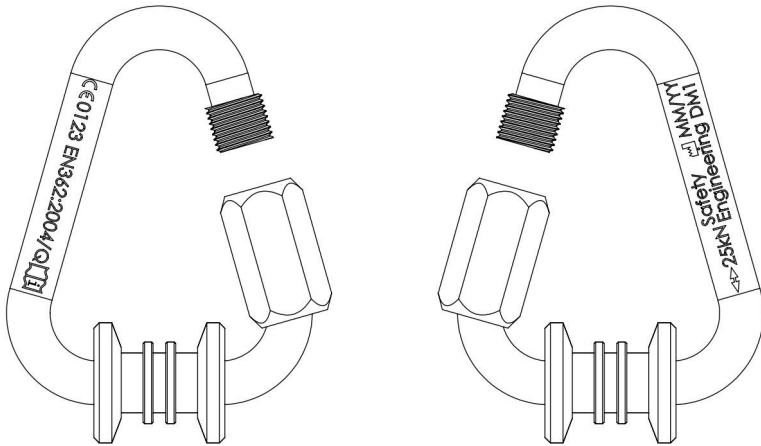

XXXX/MM/YY	XXXX – Serial No. in batch MM – Month of manufacture (e.g. 03 - March) YY – Year of manufacture (e.g. 19 - 2019)
EN 362:2004/T	Device complies with EN 362:2004 as a class T connector
20 kN	Major axis breaking load
	Read the instructions for use
	Complies with Regulation 2016/425 of European Union
0123	Number of notified body performing conformity assessment
EP3115084B1	Self Belay patent number
Sb SELF BELAY	Type name
Safety Engineering	Manufacturer



MM/YY	MM – Month of manufacture (e.g. 03 - March) YY – Year of manufacture (e.g. 19 - 2019)
EN 362:2004/T	Device complies with EN 362:2004 as a class T connector
25 kN	Major axis breaking load
	Read the instructions for use
	Complies with Regulation 2016/425 of European Union
0123	Number of notified body performing conformity assessment
DM1	Self Belay patent number
Safety Engineering	Manufacturer
MM/YY is the batch number	MM - Month of manufacture (e.g. 03 - March)
MM/YY is also the manufacturing date	YY - Year of manufacture (e.g. 19 - 2019)

3. Certification

This device is certified as a class T connector per *EN 362:2004 - Personal protective equipment against falls from a height - Connectors*.

Quicklink Delta Assembly is certified as a class Q Screwlink connector per EN 362:2004 and PPE-R- Personal protective equipment against falls from a height – Connectors.

4. Manufacturer's Details

Safety Engineering Ltd.
Address: Tsarigradsko shose 111V, 1784 Sofia, Bulgaria
VAT No: BG175376730
Email: support@safetyeng.eu

5. Conformity assessment

Conformity assessment according to Annex VII of Regulation 2016:425, modules B and C2, performed by:

TÜV SÜD Product Service GmbH Zertifizierstellen
Ridlerstraße 65
80339 Munich
Germany
Notified Body number: 0123

6. Register your device

Visit websites to activate your device warranty and receive important product updates.



<https://safetyeng.us/register-my-device/>

7. Compatibility with autobelay devices and harness

The Self Belay set is compatible with the following auto belay devices:

- Onbelay 8, 11, 14 and 17 manufactured by Safety Engineering Ltd.
- Trublue and Trublue XL manufactured by Head Rush technologies
- Perfect Descent Direct Drive and Perfect Descent Speed Drive manufactured by C3 Manufacturing LLC (Perfect Descent)*(see notice below)

NOTICE: The Self Belay Set can be retrofitted to C3 Manufacturing LLC (Perfect Descent) devices, but Safety Engineering has no formal contract with the manufacturer. Therefore, the client must contact C3 Manufacturing LLC (Perfect Descent) before installing the Self Belay device on their belays!

The Self Belay set is compatible with harnesses that conform to the following standards:

- EN 361 - Personal protective equipment for prevention of falls from a height – Full body harness.
- EN 813 - Personal protective equipment for prevention of falls from a height – Sit harness.
- EN 12277 - Mountaineering equipment - Harnesses - Safety requirements and test methods. Types A (full body harness), B (small full body harness) and C (sit harness) are approved for use.

8. Device specifications

Dimensions as installed:

Width: 63 mm Height: 200 mm (including quick link Delta assembly)
Depth: 27 mm Weight as installed: 320 g

Main body

Material: EN AW 7075-T6; AISI 304; ABS; PA 66;
C45/65Mn; AISI 304 (A2-70), S235

Major axis gate closed and locked breaking strength: 20 kN

Unlocked is not possible

Device gate opening: 14 mm

Quicklink delta assembly

Material: AISI 316

Major axis gate closed and locked breaking strength: 25 kN

Device gate opening: 12 mm

Minor axis gate closed breaking strength: 10kN

Self Belay Set can be used with wire ropes that have diameters of not less than $\phi 6.4$ mm! – up to 10 mm

Self Belay Set can be used with textile webbing that have width of min 20 mm – up to 25mm

Required strength for webbing and/or wire rope must be noted by the user/installer; not any webbing and/or wire rope shall be used.

It has to be considered, that the strength requirements of the used webbing and/or wire rope in combination with the self belay device must be conform with the relevant EN standards used for PPE against fall from a height.

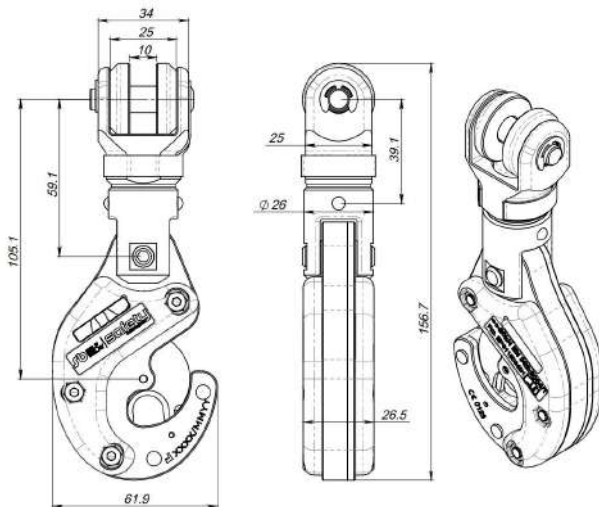

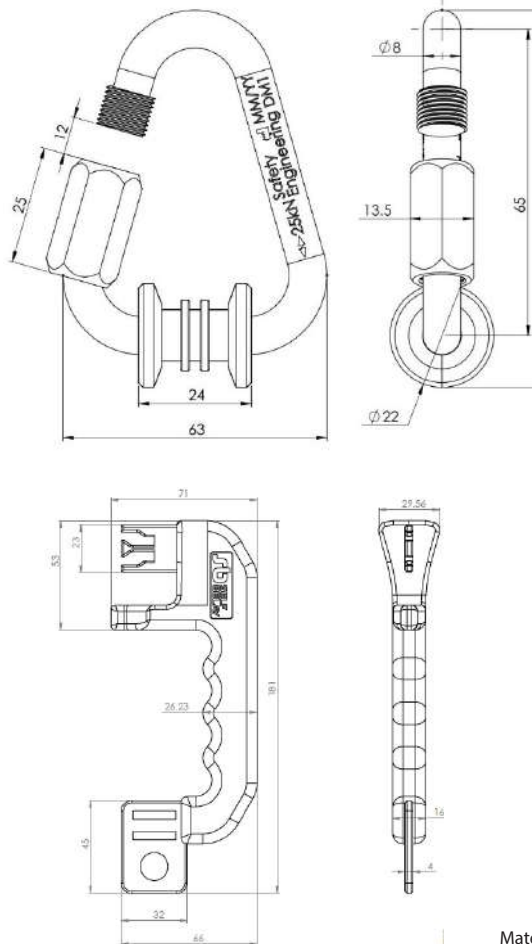

Self Belay Key
Material: AISI 304; ABS

9. Installation

In order to successfully install self belays on auto belay devices, you will need the following tools:

- A flat screwdriver
- Set of pliers

For installation on steel cable, see sections Prepare the Self Belay device(9.1) and Installation on steel cable (9.2).

For installation on textile webbing, see sections 9.1 and 9.3.

9.1. Prepare the Self Belay device

The installation of the Self Belay on a steel cable includes the following steps:

Remove the lock washer with a flat screwdriver from the folding bolt:



Lift and remove the pin assembly and the plastic washers:



9.2. Installation on steel cable

With the Self Belay device prepared, position the cable between the plastic washers:

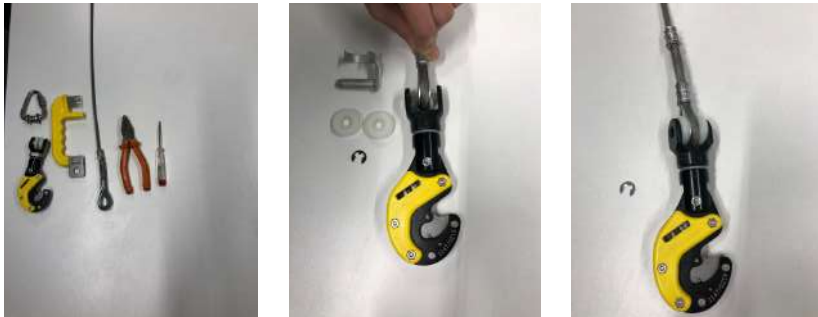

Insert the folding bolt and lock it to the body of the swivel. Make sure the bolt is securely fastened and cannot be detached from the device by hand.

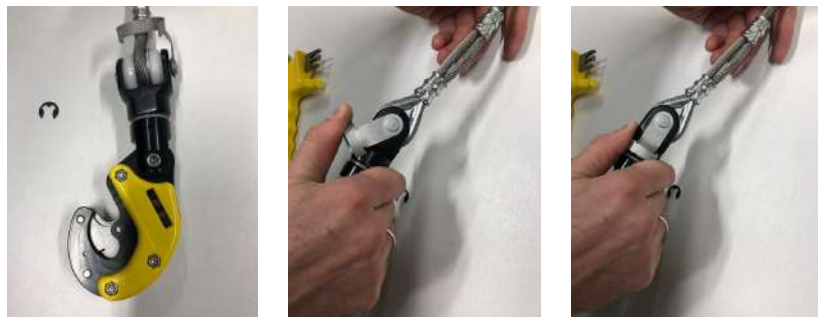

Reinstall the lock washer with pliers. Make sure the washer snaps all the way in the groove. After assembly, verify that the washer cannot be removed by hand.

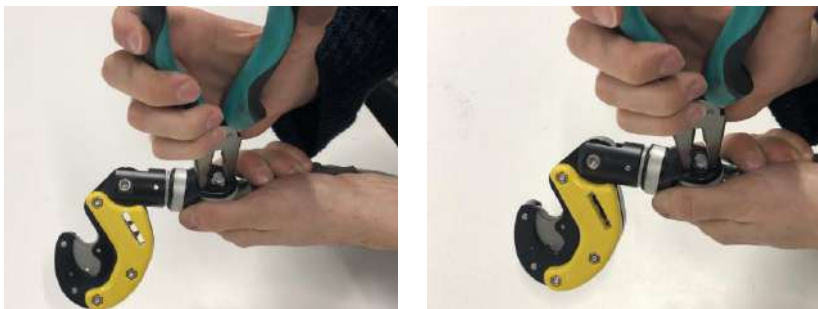

9.3. Installation on textile webbing

Self Belay can be installed on textile webbing of width 20 mm to 25 mm. Installation on other webbing sizes is not recommended.

Before you proceed, remove the plastic washers and keep them together with the original device packaging.

Place the loop of the webbing inside the opening on top of the device:

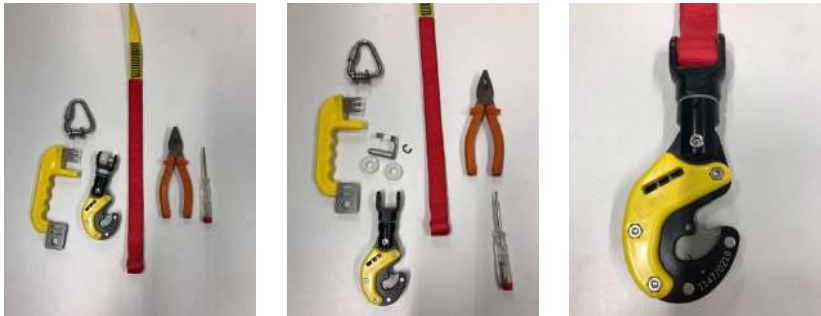

Insert the folding pin through the device and the webbing loop, then press it towards the device until it snaps firmly in place:

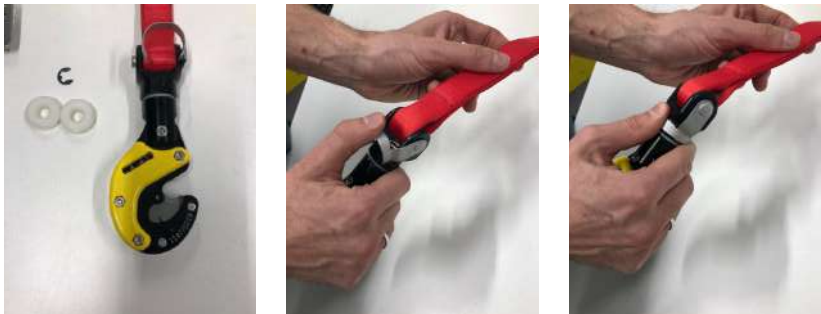

Reinstall the lock washer with pliers. Make sure the washer snaps all the way in the groove. After assembly, verify that the washer cannot be removed by hand.



9.4. Installation on quicklinks to user harness

The quicklink must be fastened securely to the harness of the user to ensure their continuous safety when using the device. Refer to section Compatibility with autobelay devices and harness for a list of compatible harnesses.



WARNING: Use only harnesses compatible with the Self Belay. Usage of other types of harnesses is not supported and does not guarantee end user safety! Connect Self Belay only to full body harnesses class A: fall arrest.

To attach:

1. Loosen the quick link nut by means of a wrench and open it completely
2. Identify the anchor point loop intended for attachment to fall arrest system. Refer to the harness user manual for the location of this attachment point.
3. Tighten the quicklink by using a wrench. Tightening torque: 3 Nm (2.21 lb.ft).
4. After installation, make sure the nut cannot be turned by hand.



9.5. Installation of Self Belay key

The Self Belay key is intended to be attached securely at a safe location where the user connects and disconnects themselves from the device. The key features rectangular openings for attachment by means of webbing, and a circular hole for a connector or other attachment type. The user must always make a function test to check if the self belay connector is completely and obviously closed and not unintentionally open.



It is strongly recommended to install protective flooring at locations where the Self Belay is used, or provide means to prevent the key from being dropped on the ground between uses. While the key by itself is sturdy enough to sustain such damage, repeated drops from height may cause its unlocking features to bend or break, causing downtime and unsafe operation.

Note that Self Belay keys showing signs of being dropped repeatedly during normal usage of the device are not subject to warranty replacement.

For maximum comfort during use by adults, the recommended height of installation of the key is around 800-900 mm (32-35 in.) from the floor. Adjust accordingly to accommodate children.



To avoid the possibility of accidents and misuse, ALWAYS make sure that the Self Belay key is attached securely to an unmovable structure or object at the ground level, or another safe location from which falling from height is very unlikely or impossible.

Self Belay keys must NEVER be left untethered and carried with the user!

Connecting and disconnecting from the Self Belay device is only allowed at a safe location on the ground level.

Failure to secure these requirements may lead to personal injury and death!

10. Usage of the Self Belay

Self Belay Set must be operational only when temperatures are above 0°C and below 38°C, and must stop working immediately when the ambient temperature is not within the specified range. Maximum allowable wind speed at the facility is 7 m/s (i.e. 25 km/h). There are no specific restrictions concerning the humidity of the environment. There are no specific restrictions concerning the altitude of the Self Belay installation site. Minimum 1 (better to be 2 qualified staff members) is required to ensure the safety and correct use of the Self Belay (together with Auto Belays) as prescribed in the manufacturer's operating instructions.

Self Belay Set Self Belay device is intended for use by a single person of weight no more than 130 kg, including their other personal protective equipment. It is strictly prohibited using the device to secure more than one person, or to use it to lift and transport goods.



USAGE WARNING: Only use the Self Belay as instructed in this manual and only for its intended purpose. If malfunction is suspected, stop operating the device and inspect the unit. The supplier and manufacturer are not liable for damage due to improper use or device alteration.

Before use, always make sure the Self Belay device, key and quicklink have been properly installed. Refer to section Installation for detailed instructions. The Self Belay comes in unlocked state before its 1st use. Operator must insert the quicklink fully and ensure the device is locked after the Self Belay, quicklink and Self Belay key are installed as per section 9. Installation. A minimum of 5 attach and detach cycles are required before launching the device for use.



USAGE WARNING: Quicklink Delta connector (class Q) is only safe for use when the screw-motion gate is fully closed, and the climber must check visually that the gate is fully closed (i.e. a thorough visual inspection) before each use.



USAGE WARNING: The length of the connector (approximately 70 mm) should be taken into account when used in fall arrest system, as it will influence the length of a fall.



USAGE WARNING: Quicklink Delta connector (class Q) should only be used where connections are infrequent.



USAGE WARNING: Quicklink Delta connector
Mandatory load direction.
Do not use on minor axis



USAGE WARNING: The tensile strength of Self Belay Kit might be reduced when its pointed end is connected to unsuitable in size and material characteristics harnesses, lanyards, suspension ropes, webbing, climbing seats, etc.



USAGE WARNING: Climbers with the following medical conditions are not allowed to use Self Belay (according to GB 8408:2018):

- 1) congenital heart defect or known heart problems;
 - 2) people who have suffered from stroke or other high blood pressure condition;
 - 3) intoxicated people, including people under the influence of drugs;
 - 4) pregnant women are not allowed to use the climbing equipment under any conditions;
 - 5) other unspecified conditions which may put the climber in danger, determined by operator (qualified staff members) discretion.
-



USAGE WARNING: The Self Belay Set must be used only by a qualified user who at least has completed a compulsory introductory briefing/course in climbing, requisite training, etc, as per climbing walls manufacturer requirements.



USAGE WARNING: A rescue plan shall be in place to deal with any emergencies that could arise during the Self Belay exploitation.

The procedure during an emergency, when for example the user is not back at the floor level is exactly the same as when using conventional carabiners. A qualified staff member (i.e. professional climbing instructor) ascends to the user's level, ties it with a spare rope, then releases it from the damaged rope and lowers it to ground level. In this particular extremely rare emergency situation, it is crucial that staff member can untie (or unlock) the Self Belay Key fixed to the ground so that the key can be used to unlock the Self Belay and the participant can be removed without any problems. If the Self Belay Key cannot be released from the ground, then the staff must have a second (additional) Self Belay Key to release the rope from the Self Belay, and the participant be completely lowered to floor level.



USAGE WARNING: Any hazards that may arise by the use of combinations of items of equipment in which the safe function of any element is affected by or interferes with the safe function of another.



USAGE WARNING: Before start of the daily operation of the Self Belay Set, the climbing wall operator must make a thorough pre-use check (inspection) of the equipment, as well as several locks and unlocks of the Delta quicklink, to examine the appearance of contact surfaces, plastic covers, contact anchors, Self Belay Key to make sure that the equipment is not defective and that all safety criteria are met.



USAGE WARNING: **1)** It is essential for safety that Self Belay Set is withdrawn immediately after any doubt arise about its suitability for safe use. **2)** It is essential for safety that Self Belay Set is withdrawn immediately after have been used to arrest a fall and not used again until confirmed in writing by a competent person that it is acceptable to do so.

The anchorage must be capable of supporting the load of a fallen climber (12kN), or shall be designed, installed and used as part of a complete personal fall arrest system which maintains a safety factor of at least 2:1, given that the maximum load permissible to be applied to a falling climber is 6kN. The connection of Self Belay to the anchor device does not differ significantly from the way of connecting ordinary carabiners at Auto Belay.



USAGE WARNING: **1)** It is essential for safety that the anchor device or an anchor attachment point is always located and that the climbing is carried out in such a way as to minimize both the possibility of falling and the potential distance of falling. **2)** It is important for safety before each climbing to check the free space required under the user's workplace so that in the event of a fall there will be no collision with the ground or other obstacle in the fall path.

In order to protect the **Self Belay Set** from damage during transportation, it must be transported closed in the factory cardboard packaging (cushioned showcase box) of the manufacturer, in which they are positioned in specially shaped embossed grooves, which perform the function of a protective bandage.



USAGE WARNING: It is essential for the safety of the climber that if the product is resold outside the original country of manufacture, the local distributor must provide instructions for use, maintenance, periodic inspection and repair in english.

The markings (technical symbols) written on the Self Belay Set (Self Belay device, Self Belay Key, and Delta Quicklinks) must be periodically checked for legibility.

To attach:

- Insert the quicklink in the opening of the Self Belay device. Push the quicklink all the way down into the device; the locking discs of the device rotate as you push the quicklink.
- When the quicklink is properly inserted, the Self Belay key can now be removed; pull it away and release it.
- Make sure that the device is properly locked; try removing the quicklink from the device to verify that it is firmly secured in place.
- Start climbing!



To detach:

- Take the Self Belay key and insert it all the way in the opening on the side of the Self Belay.
- Pull the quicklink away from the device.
- You are now disconnected from the Self Belay

11. Inspection and maintenance



Careful inspection is paramount to maintaining device safety; perform the inspection procedures outlined in this section diligently and in a timely manner. Failure to follow these procedures may lead to severe personal injury or even death!

You as an end user or operator assume complete responsibility for incidents arising from lack of timely inspection and/or maintenance.

11.1. Daily inspection

Self Belay device and its components must be inspected daily by authorized person, before the start of each work day in order to ensure their safety and smooth operation. The following procedures shall be followed in order to ensure optimal safety and efficiency.

1. Overall device check

Inspect visually the Self Belay device; note any missing, deformed or broken components.

Note: during use, it is normal for the device to receive occasional scratches and accumulate surface damage from contact with rough surfaces. Coating will also start wearing out, particularly in areas where the device is being held while opening or closing, as well as areas around the key and quicklink opening. This is normal and to be expected. In case of any signs of wearing out of the main body's structure, the device shall be taken out of usage and sent for recertification to the manufacturer.

2. Self Belay key check

Inspect closely the Self Belay key; pay particular attention to the condition of the three pins. If any of the pins is bent, partly or completely broken, stop using the key and replace it immediately.



3.Swivel check

The condition of the swivel must be checked by twisting the upper part as shown in Photo 1 below. It should rotate freely in both directions.

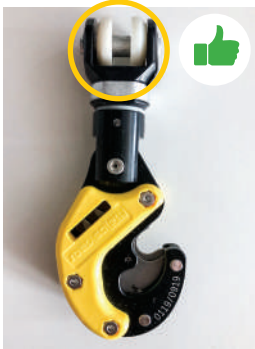

Check highlighted area for cracks, deformations or damage



Devices with damaged or deformed swivels must not be used

If the swivel is deformed, damaged or shows signs of cracking, stop using the device immediately. Contact Safety Engineering for a replacement.

4.Self Belay covers check

The plastic covers on both sides should be inspected for cracks and damage; missing or damaged covers should be replaced in a timely manner. Note that the covers are not part of the warranty for the device as they are considered consumable.



5. Self Belay key measurement (Inspection required on weekly basis)

Measure the width of the middle pin of the Self Belay key as shown; measured value should be above 3.3 mm. This dimension is between 3.8 and 4.0 mm as manufactured; if the measured value is close (but still above) 3.3 mm, order replacement keys.

If the key fails the measurement check, replace it immediately before using the device again.



Pin width OK



Key requires replacement

6. Swivel pin check

Inspect the swivel pin for damage or deformation; stop using the device immediately if the pin is broken or deformed!

Make sure that the lock washer in the end of the swivel pin is present and cannot be removed by hand. If the washer has fallen out, stop using the device until the washer is replaced.

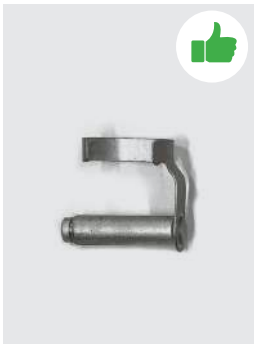

7. Quicklink check

Inspect the quicklinks that are currently in use on participant harnesses; note any damage, cracks or permanent deformation of the quicklink. Make sure the attachment rotates freely.

Check for wear the place where the quicklink is in contact with the harness; if there is visible wear, measure the smallest thickness in the worn out place; minimum thickness should be at least 6.5 mm.

Make sure the nut of the quicklink is tightened well when installed on the harness. If loose, tighten carefully of minimum torque: 3 N.m.

If the quicklink is deformed, damaged or worn out beyond threshold value given above, stop using the quicklink and replace it immediately.

8. Functional check

When all previous checks are completed, proceed to check the functionality of the device. Insert quicklink in the device as normal; the quicklink should slide in easily and without effort. Rotation of the discs should be smooth and without friction.

If the discs rotate with difficulty, apply dry lubricant in spray form (e.g. graphite or silicone-based) and insert the quicklink several times to spread out the lubricant.

With the quicklink inserted all the way, remove the key from the device; key should slide out easily without excessive effort.

When the key is out of the device, verify that the Self Belay is firmly locked and the quicklink cannot be taken out.

Replace the key in the device and remove the quicklink from the Self Belay; quicklink removal should be easy and not require excessive effort.

Verify that the key cannot be removed from the device when the quicklink is not inserted.

Repeat the steps above at least 3 times.

9. Swivel Rivet Pin check

Inspect closely the rivet pin: if the rivet pin is missing or is showing any signs of movement, the device shall be taken out of use immediately.

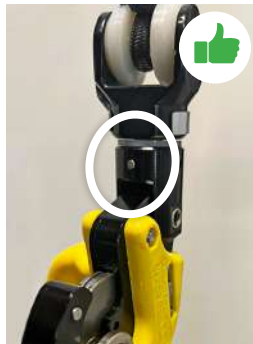

11.2. General care

The following instructions are provided as general recommendation in order to prolong the life of the device; they are not obligatory.

- **Usage environment:** Do not expose the device to continuously to chemical reagents as well as corrosive or very humid (RH>80%) environment. If accidentally exposed, remove the device from use immediately and keep in an indoors dry and warm location for at least 24 hours. This reduces the risk of corrosion of the internal components of the device due to corrosive or chemical agents buildup.
- **Cleaning (device only):** Clean the exterior of the Self Belay device with a damp cloth with small amount of mild detergent. Do not submerge the device in water! Let the device dry completely before next use.
- **Cleaning, (Self Belay key and quicklink):** These components are made from stainless steel and are safe to wash. Use mild detergent and wash well. Let the components dry naturally before use.
- **Disinfection.** Use pure ethanol only (at least 80% proof). Spray or pour small amount on a dry cloth and clean thoroughly. If using spray, make sure not to spray directly inside the device; always apply the disinfectant to a cloth and clean thoroughly. Let the components dry before subsequent use.
- **Lubrication:** Small amount of general-purpose, low viscosity silicone oil or graphitebased dry lubricant in spray form can be used.
- **Storage:** Keep in dry, well-ventillated place away from direct sunlight, extreme temperatures, and corrosive or aggressive substances.
- **Transportation:** Device is transported in its own package for protection against mechanical damage and environmental conditions. Keep the original packaging whenever possible and use it when trans-orting the device to another location for e.g. warranty, repair, re-certification etc. If the original packaging is not kept, wrap the device in soft packaging materials, and seal in a box for shipping.

11.3. Checklist

Component	Check	Action	Frequency
Self belay device	Is it damaged, deformed, or have missing parts?	Stop using the device immediately. Contact manufacturer for replacement device.	Daily
	Missing, damaged or deformed covers?	Replace covers in shortest time possible; device may continue to be used up to 7 days	Daily
	Quicklink difficult to insert in the device or jams?	Apply lubrication and operate the device several times. If a problem persists, contact the manufacturer for a replacement device.	Daily
	If the Swivel Rivet Pin missing or moving?	Stop using the device immediately. Contact manufacturer for replacement device.	Daily
Self Belay key	Missing, damaged or deformed middle pin?	Stop using the key immediately.	Daily
	Middle pin thickness below 3.3 mm?	Stop using the key immediately.	Weekly
Self Belay quicklink	Damaged, deformed or having missing parts?	Stop using the quicklink immediately.	Daily
	Is the quicklink nut loose or unscrewable by hand?	Immediately tighten the quicklink by using a wrench. Tightening torque: 3 Nm (2.21 lb.ft)	Daily
	Is the quicklink nut tightened at 3Nm?	Immediately tighten the quicklink by using a wrench. Tightening torque: 3 Nm (2.21 lb.ft)	Monthly
	Minimum thickness below 6.5 mm?	Stop using the quicklink immediately.	Weekly
Self Belay swivel	Damaged, deformed or not rotating smoothly?	Stop using the device immediately. Contact the manufacturer for a replacement device.	Daily
	Folding pin deformed or damaged?	Stop using the device immediately. Replace the folding pin.	Daily
	Missing or deformed lock washer	Stop using the device. Replace the washer.	Daily

11.4. Annual maintenance and recertification











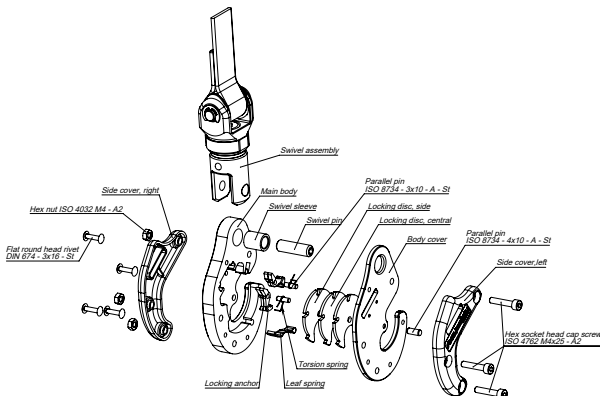

WARNING: Failure to send devices for inspection within the time frame outlined below could result in serious injury or death.







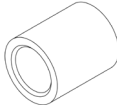

Maintenance and repair must be performed by device manufacturer (Safety Engineering) or authorized representative of Safety Engineering. Unauthorized disassembly or repair are strictly forbidden.

1. 11 months after the Self Belay/s have been in use, the customer contacts the manufacturer (Safety Engineering) at support@safetyeng.eu.
2. For a fixed price, the manufacturer sends out new or refurbished devices to the client. The client is then required to send back their old devices to the manufacturer within a week of receiving the replacement ones. This is to ensure that the old devices are not mistakenly still used after the reception of the replacement devices. Visit <https://safetyeng.us/product/self-belay-re-certification> (USA and Canada) <https://safetyeng.eu/product/self-belay-re-certification/> (Europe and rest of the world) for more information and pricing.
3. The new or refurbished devices are warranted for a further 12 months from the date of arrival to the client.
4. Any damages that make the Self Belay unsafe within the warranty period will be dealt with as defined in section Warranty information *Warranty information*.
5. Annual maintenance, repair and recertification must only be performed by the device manufacturer (Safety Engineering), or by an authorized representative of Safety Engineering. The annual control, unauthorized disassembly or repair are not allowed to be done by any other person!

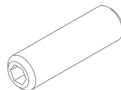
Components of the Self Belay that may need to be replaced during annual maintenance

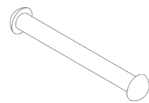
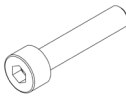

Component	Image	OEM number	Quantity
Locking disc, central		SE.SB.P00005	1
Locking disc, side		SE.SB.P00006	2
Locking anchor, left		SE.SB.P00007L	1
Locking anchor, right		SE.SB.P00007R	1
Sheet spring		SE.SB.P00008	1
Positioning spring		SE.SB.P00009	1
Positioning roller		SE.SB.P00010	1
Side cover, right		SE.SB.P00011	1
Side cover, left		SE.SB.P00012	1

Component	Image	OEM number	Quantity
Bushing		SE.SB.P00015	1
Folding spring bolt		SE.SB.P00018	1
Swivel pin		SE.SB.P00019	1
Torsion spring - left		SE.SB.P00032L	1
Torsion spring - right		SE.SB.P00032R	1
Lock washer, E-type		DIN 6799 - 7	1
Flat round head rivet		DIN 660 3x28	1
Hex socket head cap screw		ISO 4762 M4x22 A2-70	3
Hex nut		DIN 985 M4	3

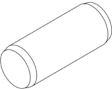
Component	Image	OEM number	Quantity
Locking anchor pin		ISO 8734 3x10	3
Central pin		ISO 8734 4x10	1

12. Lifespan

- The **Self Belay** has a lifespan of **12 months**, which can be extended up to 5 years with re-certification. The lifespan of **Self Belay Key** and **Quicklink Delta assembly** is 6 months, and the client is obliged to periodically monitor their condition during these 6 months. It is imperative that the clients send their **Self Belays** for inspection every year as described in section Annual Maintenance of this manual, in order to ensure safe operation and extended lifespan of the devices.

13. Warranty information



Read this section carefully as it contains important information.

Self Belay body: The Self Belay body is warranted for 12 months, counted from the date of arrival to the client.

Any damage, excluding normal wear and tear or unauthorized tinkering with the device by the client or third parties, that leads to the device being dysfunctional or unsafe within the 12 month period obliges the manufacturer (Safety Engineering) to send (a) replacement new or refurbished device/s to the customer at no cost. The replacement device will be warranted for the remainder of the 12 month period and the additional operational time that the client has lost while waiting for the replacement device/s.

Self belay accessories: (Self Belay key and delta quicklink):

The Self Belay key and delta quicklink are warranted for 6 months from the date of arrival to the client. Any manufacturing defects that leads to the device being dysfunctional or unsafe within the 6 month warranty period obliges the manufacturer to send (a) replacement new or refurbished device/s to the customer at no cost. The replacement device will be warranted for the remainder of the 6 month period and the additional operational time that the client has lost while waiting for the replacement device/s.

Consumables: Self Belay plastic covers

The Self Belay plastic covers are consumable parts. To order replacements, please contact us at support@safetyeng.eu or order online: <https://safetyeng.us/product/self-belay-cover-set/> (USA and Canada) or <https://safetyeng.eu/product/self-belay-cover-set/> (Europe and the rest of the world).

14. Declaration of conformity



EU declaration of conformity can be downloaded from this address:
<https://safetyeng.eu/self-belay/>

15. Further information



If you have further questions or inquiries, please contact us by email (support@safetyeng.eu) or through our website (<https://safetyeng.eu>).

16. Product Inspection

The product needs to be inspected at least once a year by the device manufacturer (Safety Engineering), or by an authorized representative of Safety Engineering. The following equipment record must be kept with this operation manual.

Product name: Model number: Name of user: Date of first use:		Manufacturer: Safety Engineering OOD Year of manufacture: as per device's marking Date of purchase: Supplier name:
Approved on (date) by (Signature)	Comments	Date of next inspection